

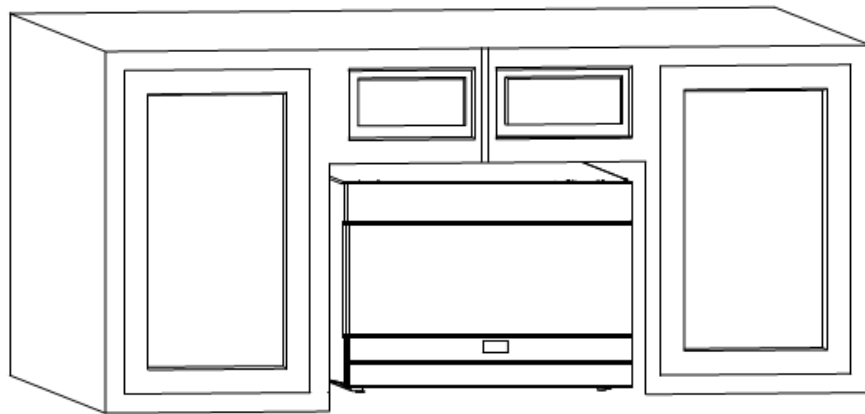

OVER THE RANGE INSTALLATION INSTRUCTIONS



Models:
MHOTR241W
MHOTR242B
MHOTR243SS

**BEFORE USE, PLEASE READ AND FOLLOW ALL SAFETY RULES AND OPERATING
INSTRUCTIONS**

Write Model & Serial Nos. here:

Model No. _____

Serial No. _____

FELIX STORCH, INC.
An ISO 9001:2015 registered company
770 Garrison Avenue
Bronx, NY 10474
www.summitappliance.com

TABLE OF CONTENTS

General Information	3-8
<i>Before you Begin</i>	3
<i>Important Safety Instructions</i>	3
<i>Electrical Requirements</i>	4
<i>Hood Exhaust</i>	4-6
<i>Parts Included</i>	7
<i>Installation Accessories</i>	7
<i>Tools Needed</i>	7
<i>Mounting Space</i>	8
Installation Instructions	9-25
<i>Placing the Mounting Plate</i>	9
<i>Finding your Wall Studs</i>	9
<i>Finding the Top Line Under your Cabinet</i>	10-12
<i>Aligning the Top Line of your Rear Wall Template</i>	13
<i>Installation Types</i>	14
<i>Installation Instructions for Outside Top Exhaust</i>	15-18
<i>Installation Instructions for Outside Back Exhaust</i>	18-22
<i>Installation Instructions for Recirculating Microwaves</i>	22-25
Before Using your Microwave	25
Wall Templates	27

GENERAL INFORMATION

This installation guide will show you how to install your new over-the-range microwave.

Before you Begin

Read these instructions completely and carefully.

- IMPORTANT – Save these instructions for local inspector's use.
- IMPORTANT – Observe all governing codes and ordinances.
- Note to Installer – Be sure to leave these instructions with the consumer.
- Note to Consumer – Keep these instructions for future reference.
- Skill level – Installation of this appliance requires basic mechanical and electrical skills.
- Proper installation is the responsibility of the installer.
- Product failure due to improper installation is not covered under the Warranty.

Important Safety Instructions

IMPORTANT–PLEASE READ CAREFULLY. FOR PERSONAL SAFETY, THIS APPLIANCE MUST BE PROPERLY GROUNDED TO AVOID SEVERE OR FATAL SHOCK.

- This product requires a three-prong, properly grounded outlet for safe operation. If not properly grounded, or if the outlet does not meet the electrical requirements listed in the *Electrical Requirements* section below, a qualified electrician should be employed to correct any deficiencies.
- The power cord of this appliance is equipped with a three-prong (grounding) plug which mates with a standard three-prong (grounding) wall receptacle to minimize the possibility of electric shock hazard from this appliance.
- You should have the wall receptacle and circuit checked by a qualified electrician to make sure that the receptacle is properly grounded.
- Where a standard two-prong wall receptacle is encountered, it is very important to have it replaced with a properly grounded three-prong wall receptacle installed by a qualified electrician.

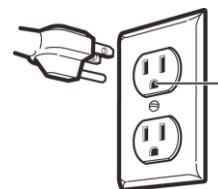

NOTE: For easier installation and personal safety, it is recommended that two people install this product.

Caution

- For personal safety, remove the house fuse or open the circuit breaker before beginning installation to avoid severe or fatal shock injury.
- For personal safety, the mounting surface must be capable of supporting the cabinet load, in addition to the added weight of this 50-70 pound (22.6-31.7 kilogram) product, plus addition oven loads of up to 50 pounds (22.6 kilograms) for a total weight of 100-120 pounds (45.2-54.3 kilograms).
- For personal safety, this product cannot be installed in cabinet arrangements such as an island or a peninsula. It must be mounted to BOTH a top cabinet AND a wall.

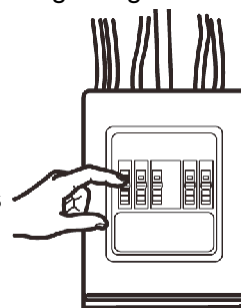

Electrical Requirements

The product rating of your microwave is 120 volts AC, 60 Hertz, 13.5 amps, and 1.5 kilowatts. This product must be connected to a supply circuit of the proper voltage and frequency. Wire size must conform to the requirements of the National Electrical Code or the prevailing local code for this kilowatt rating. The power supply cord and plug should be brought to a separate 20 ampere branch circuit single grounded outlet. The outlet box should be located in the cabinet above the microwave oven. The outlet box and supply circuit should be installed by a qualified electrician and conform to the National Electrical Code or the prevailing local code.



Hood Exhaust

This section only applies if you plan to vent your exhaust outside. If you plan to recirculate the air back into the room, proceed to page 9.

OUTSIDE TOP EXHAUST (EXAMPLE ONLY)

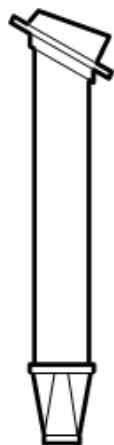
The following chart describes an example of one possible ductwork installation:







DUCT PIECES		EQUIVALENT LENGTH	NUMBER x USED	=	EQUIVALENT LENGTH
	Roof Cap	24 Ft.	x (1)	=	24 Ft.
	12 Ft. Straight Duct (6" Round)	12 Ft.	x (1)	=	12 Ft.
	Rectangular-to-Round Transition Adaptor*	5 Ft.	x (1)	=	5 Ft.
Equivalent lengths of duct pieces are based on actual tests and reflect requirement for good venting performance with any vent hood.					Total Length = 41 Ft.

NOTE: If a rectangular-to-round transition adaptor is used, the bottom corners of the damper will have to be cut to fit, using the tin snips, in order to allow free movement of the damper.

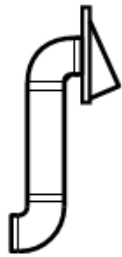
OUTSIDE BACK EXHAUST (EXAMPLE ONLY)

The following chart describes an example of one possible ductwork installation.



DUCT PIECES		EQUIVALENT LENGTH*	NUMBER x USED	=	EQUIVALENT LENGTH
	Wall Cap	40 Ft.	x (1)	=	40 Ft.
	3 Ft. Straight Duct (3 1/4" x 10" Rectangular)	3 Ft.	x (1)	=	3 Ft.
	90° Elbow	10 Ft.	x (2)	=	20 Ft.
Equivalent lengths of duct pieces are based on actual tests and reflect requirement for good venting performance with any vent hood.					Total Length = 63 F t.

NOTE: Align the exhaust with the space between the studs, or the wall should be prepared at the time it is constructed by leaving enough space between the wall studs to accommodate the exhaust.

Exhaust connection

The hood exhaust has been designed to mate with a standard 3 1/4"x10" rectangular duct. If a round duct is required, a rectangular-to-round transiting adaptor must be used. Do not use less than a 6" diameter duct.





NOTE: It is important that venting be installed using the most direct route and with as few elbows as possible. This ensures clear venting of exhaust and helps prevent blockages. Also, make sure dampers swing freely and nothing is blocking the ducts.

Maximum duct length

For satisfactory air movement, the total duct length of 3 1/4"x10" rectangular or 6" diameter round duct should not exceed 140 feet.

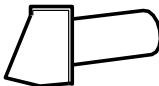

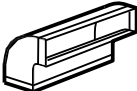
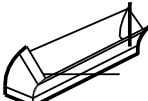

Elbows, Transitions, Wall and Roof caps

Several duct pieces may present additional resistance to airflow and are equivalent to a section of straight duct which is longer than their actual physical size. When calculating the total duct length, add the equivalent lengths of all transitions and adaptors plus the length of all straight duct sections. The chart below shows you how to calculate total equivalent ductwork length using the approximate feet of equivalent length of some typical ducts.

DUCT PIECES		EQUIVALENT LENGTH	x	NUMBER USED	=	EQUIVALENT LENGTH	
	Rectangular-to-Round Transition Adaptor*	5 Ft.	x	()	=	Ft.	
	Wall Cap	40 Ft.	x	()	=	Ft.	
	90° Elbow	10 Ft.	x	()	=	Ft.	
	45° Elbow	5 Ft.	x	()	=	Ft.	
	90° Elbow	25 Ft.	x	()	=	Ft.	
	45° Elbow	5 Ft.	x	()	=	Ft.	
	Roof Cap	24 Ft.	x	()	=	Ft.	
	Straight Duct 6 " Round or 3 1/4" x 10" Rectangular	1 Ft.	x	()	=	Ft.	
					Total Duct work	=	F t.





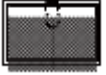

NOTE: If a rectangular-to-round transition adaptor is used, the bottom corners of the damper will have to be cut to fit, using the tin snips, in order to allow free movement of the damper. Equivalent lengths of duct pieces are based on actual tests and reflect requirements for good venting performance with any vent hood.

Parts Included

Part						
	Mounting Plate	Exhaust Adapter	Top Cabinet Template	Rear Cabinet Template	Installation Instructions	Separately Packed Grease Filter
Quantity	1	1	1	1	1	2

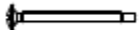











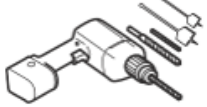

Installation Accessories

The installation accessories are located in a packet, stored within the unit. Check to make sure all of the listed parts are included.

Part							
	Wood Screw (1/4" x 2")	Wing Nut	Machine Screw (3/16" x 3")	Self-aligning Machine Screw (1/4" - 20 x 3")	Nylon Grommet	Washer	Sheet Metal Screw
Quantity	2	2	2	2	1	2	2

NOTE: Some extra parts may be included.

Tools Needed

			
#1 and #2 Phillips screwdrivers	Pencil	Ruler or tape measure straight edge	Carpenter square (optional)
			
Tin snips (to cut damper, if needed)	Scissors (to cut template, if needed)	Electric drill with 3/16", 1/2", and 5/8" bits	Filler blocks or scrap wood pieces (for top cabinet spacing in recessed bottom cabinet installations, if needed)
			
Gloves	Safety goggles	Duct and masking tape	
			
Saw (saber, hole, or keyhole)	Level	Edge-to-edge stud finder or Hammer (optional)	

Mounting Space

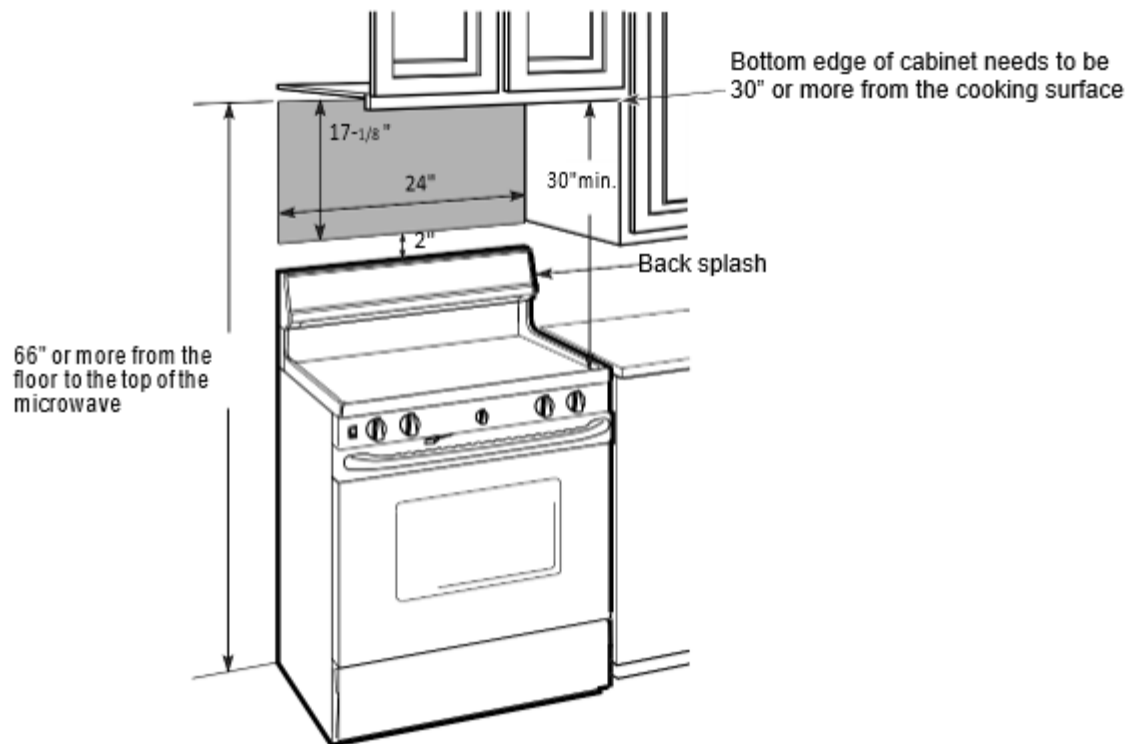

NOTES:

- The space between the cabinets must be 24" wide and free of obstructions.
- When installing the microwave beneath smooth, flat cabinets, be careful to follow the instructions for power cord clearance. Make sure to leave enough space for power cord clearance.
- To vent your microwave to the outside, see the *Hood Exhaust* section for exhaust duct preparation instructions.

INSTALLATION INSTRUCTIONS

Placing the Mounting Plate

1. Open the microwave box, and remove the microwave. It will be wrapped in a plastic bag.
2. Remove the plastic bag, being careful to save the upper foam, where the mounting bracket is located.
3. Remove the mounting bracket from the upper foam.

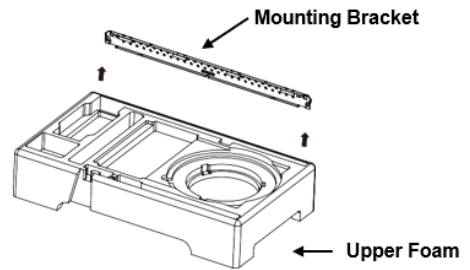

Finding your Wall Studs

NOTE: The microwave must be anchored to at least one wall stud.

Locating a wall stud can be done by using a magnetic stud-finder or tapping lightly across the mounting surface to find a solid sound. The location of the solid sound should be the location of the stud.

1. Find the center of the stud by probing a small nail into the wall to find the edges of the stud.
2. Place a mark halfway between the edges. The center of the adjacent stud should be 16" or 24" from this mark.
3. Draw a line down the center of the wall studs.

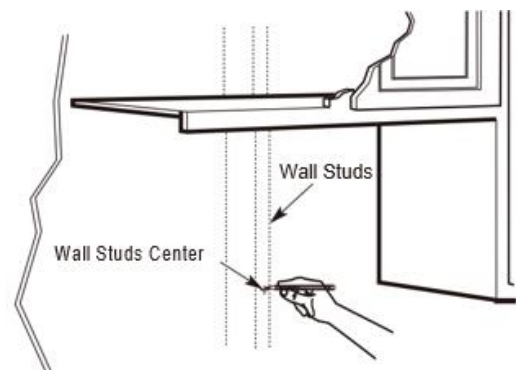

Finding the Top Line Under your Cabinet

There are typically three types of cabinet bottoms under which you will install your microwave:

Flat Bottom Cabinet

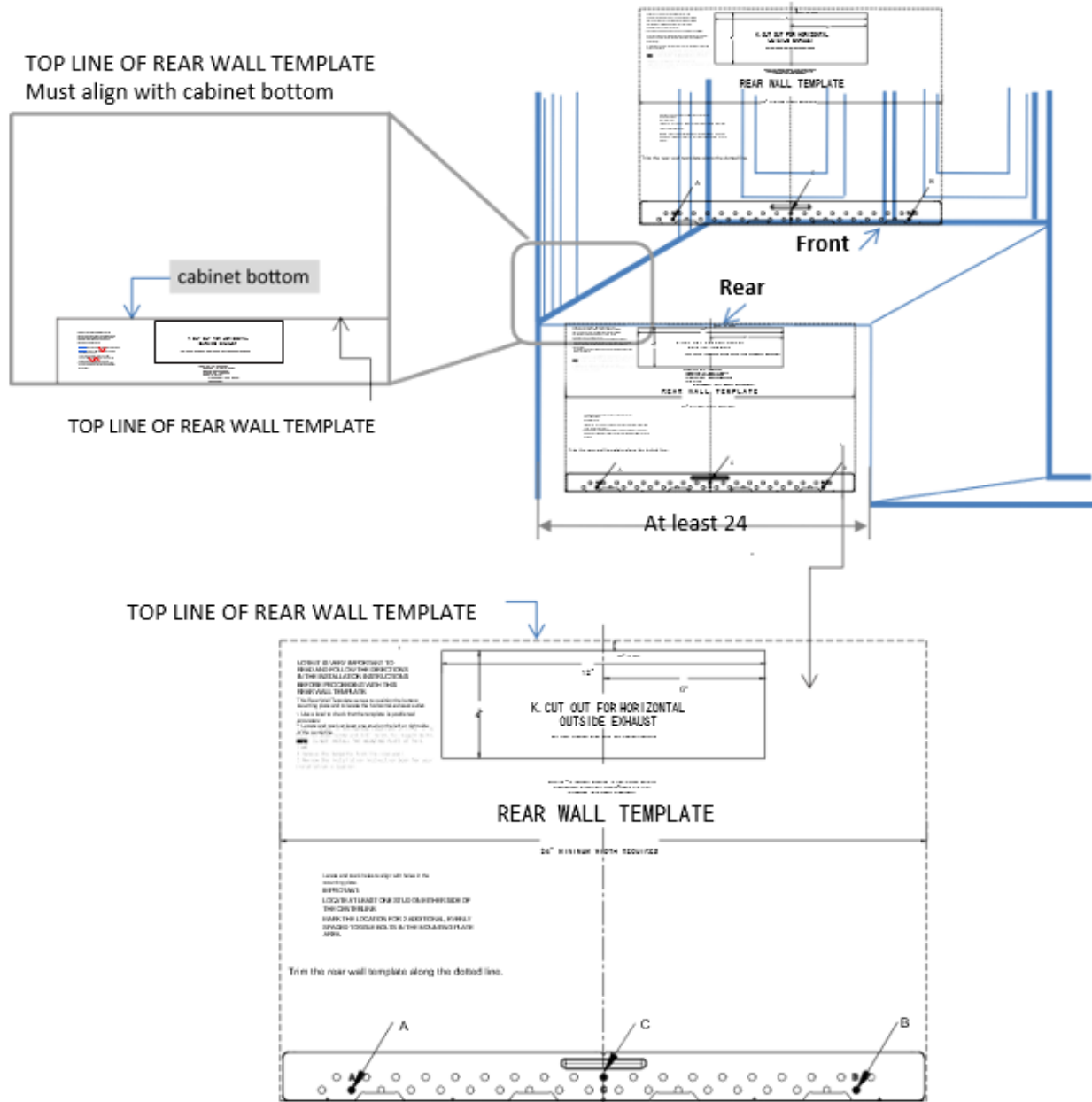

Framed Recessed Cabinet

TOP LINE OF REAR WALL TEMPLATE

Must align with the back frame of cabinet bottom

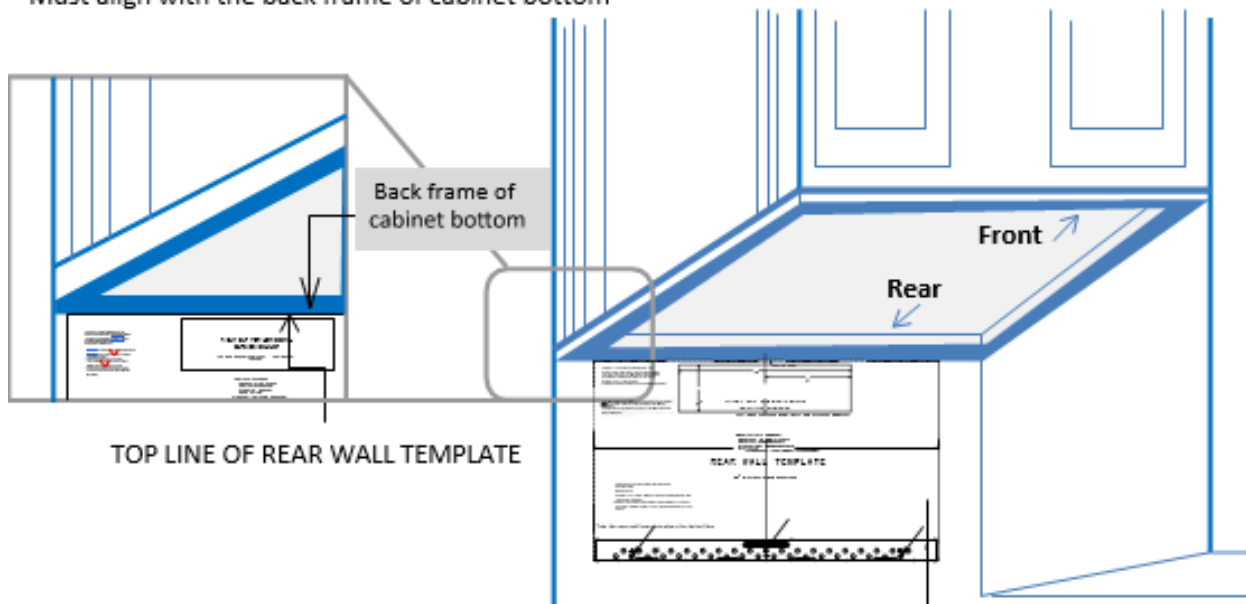

TOP LINE OF REAR WALL TEMPLATE

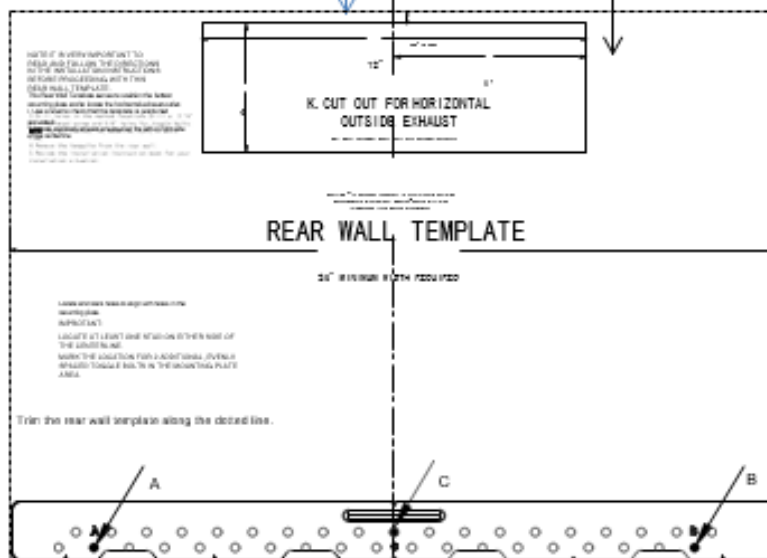

Framed Recessed Cabinet with Front Overhang

TOP LINE OF REAR WALL TEMPLATE

Must align with below cabinet bottom the same distance as the front overhang of cabinet bottom.

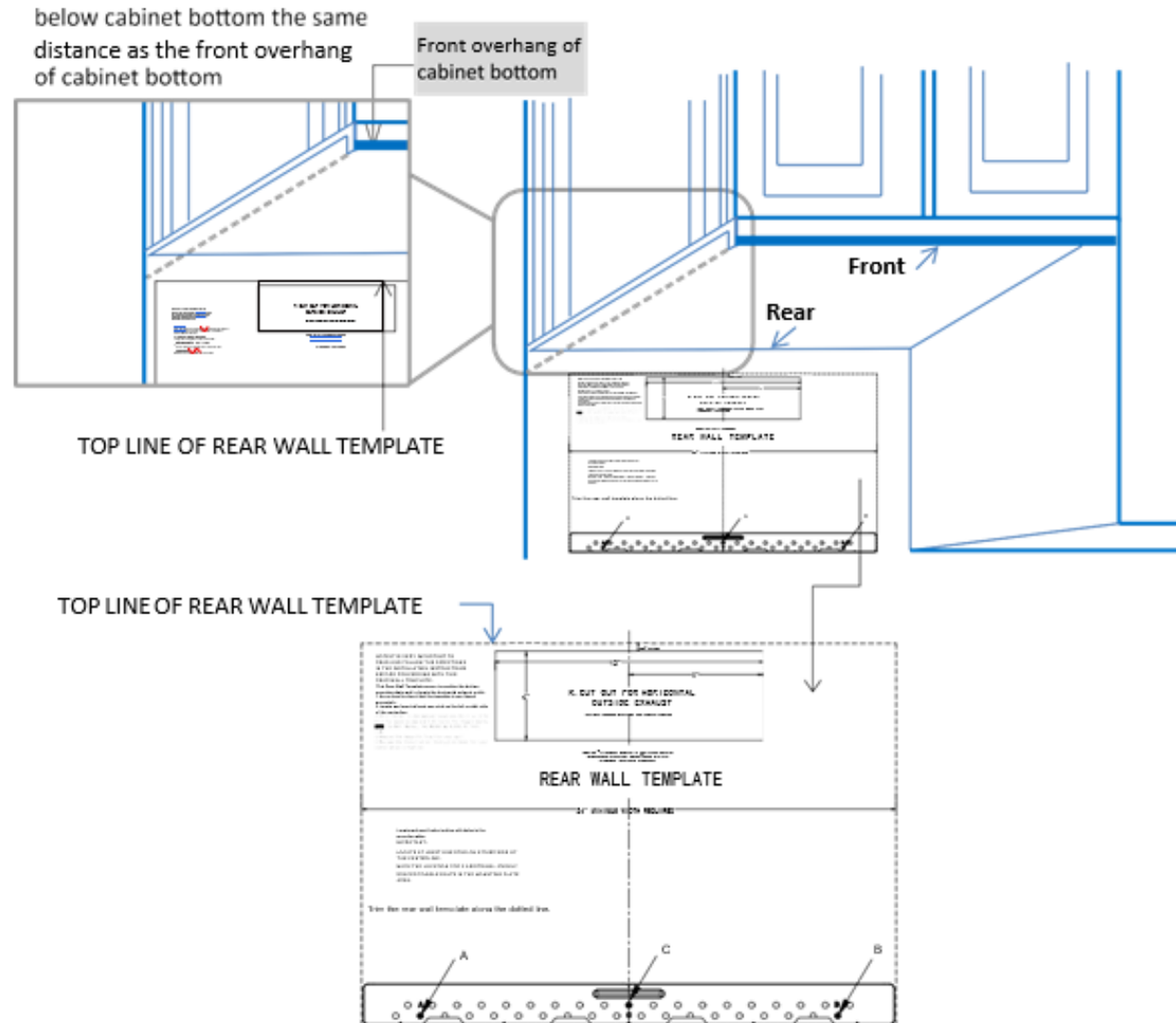

Your cabinets may have decorative trim that interferes with the microwave installation. Remove the decorative trim to install the microwave properly and to make it level.

THE MICROWAVE MUST BE LEVEL

Use a level to make sure the cabinet bottom is level. If the cabinets have a front overhang only, with no back or side frame, the top line of the rear wall template must align below cabinet bottom by the same distance as the front overhang depth. This will keep the microwave level.

1. Measure the inside depth of the front overhang.
2. Draw a horizontal line on the back wall an equal distance below the cabinet bottom as the inside depth of the front overhang.
3. For this type of installation with front overhang only, align top line of rear wall template with this horizontal line, not touching the cabinet bottom as described in step D.

Aligning the Top Line of your Rear Wall Template

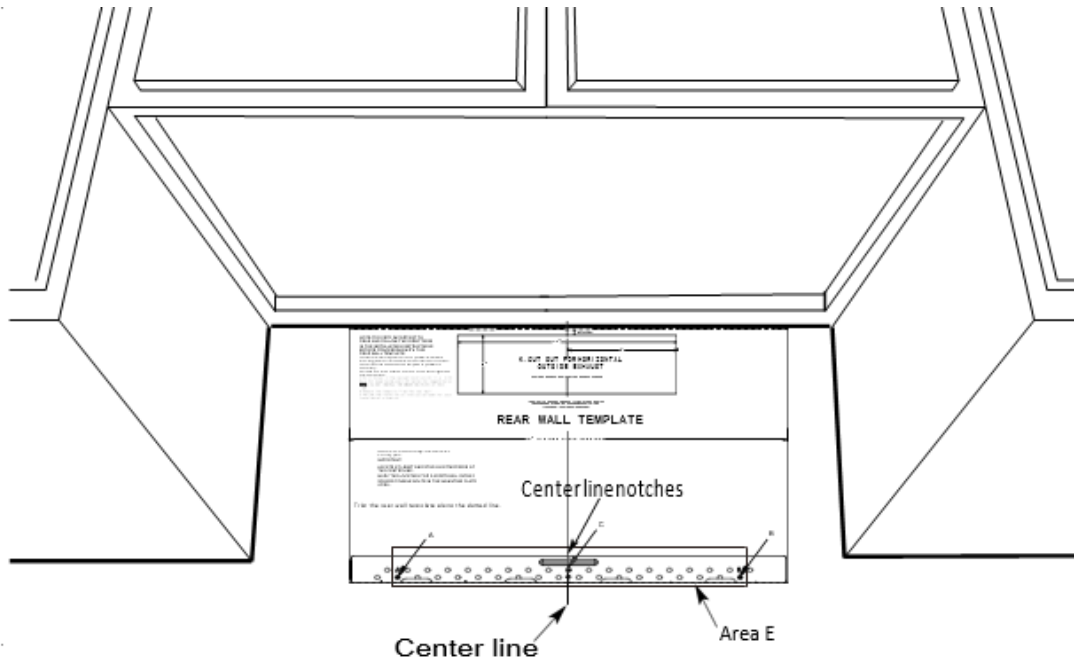

CAUTION: Wear gloves when installing to prevent cutting your fingers on sharp edges.

1. Using a tape measure, draw a vertical line on the wall at the center of the 24" wide space.
2. Tape the rear wall template on the wall, aligning the center marks on the rear wall template with the center line on the cabinet.
3. The location of the rear wall template will depend on what type of cabinet you are installing the microwave under. (See above examples.)
4. After taping the rear wall template to the wall, draw circles at the A, B, and C holes (see above illustration).

NOTE: You must use all three mounting holes. It is recommended to use four mounting holes if there are 2 wall studs on the left and 2 wall studs on the right of the center line.

5. Remove the rear wall template, and check the markings based on the actual mounting plate (centerline, hole A, B, and C).
6. Drill holes on the circle marks for A, B, and C. Use a 3/16" bit for hole C (to mount into the wooden stud) and a 5/8" bit for A and B (to secure with a toggle bolt).

NOTE: Do not mount the plate yet.

7. If the rear wall template is damaged or unusable, measure and mark the wall with the dimensions shown to the right:

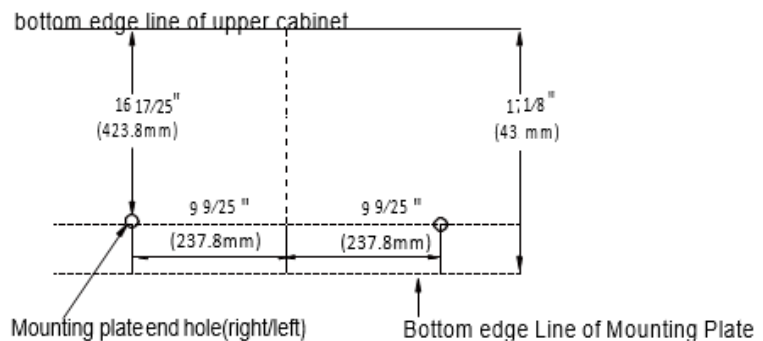

Installation Types

This microwave is designed to be adapted to the following three types of installation:

- A. Outside Top Exhaust (Vertical Duct)
- B. Outside Back Exhaust (Horizontal Duct)
- C. Recirculating (Non-Vent/Ductless)

A: Outside Top Exhaust (Vertical Duct)

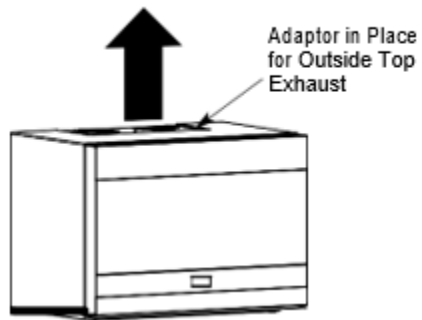

B. Outside Back Exhaust (Horizontal Duct)



C. Recirculating (Non-Vent/Ductless)

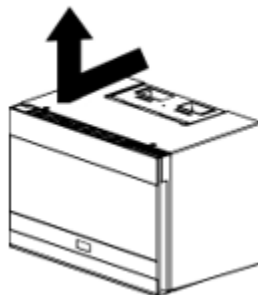

Installation Instructions for Outside Top Exhaust

Attaching the Mounting Plate

Attach the mounting plate to the wall using the wing nuts and screws. At least one wood screw must be used to attach the mounting template to the wall stud.

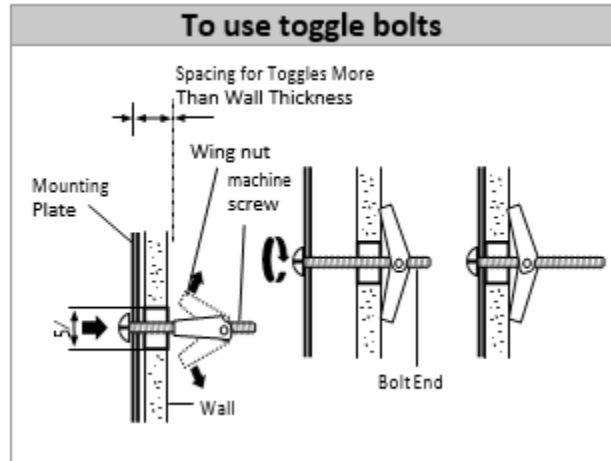
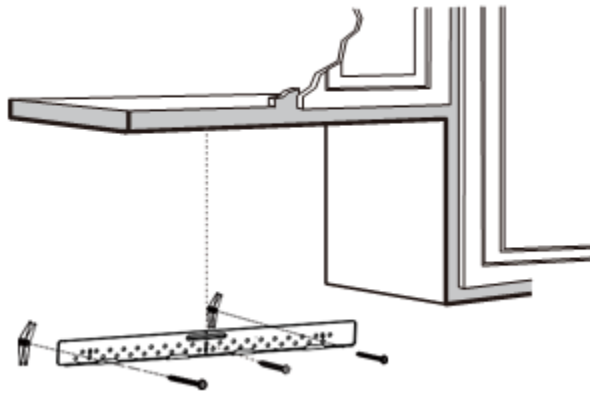

1. Remove the toggle wings from the bolts.
2. Insert the bolts into the mounting template through the holes designed to go into drywall, and reattach the toggle wings to $\frac{3}{4}$ " onto each bolt.
3. Place the mounting plate against the wall and insert the toggle wings into the holes in the wall to mount the plate.

NOTE: Before tightening toggle bolts and wood screw, make sure the bottom of the mounting plate touches the bottom of the cabinet when pushed flush against the wall and that the plate is properly centered under the cabinet.

Prepare the Top of the Cabinet

You need to drill holes for the top support screws large enough for the power cord to fit through, and a cutout large enough for the exhaust adaptor.

- Read the instructions on the TOP CABINET TEMPLATE
- Tape it underneath the top cabinet bottom
- Drill the appropriate holes, following the instructions on the TOP CABINET TEMPLATE

CAUTION: Wear safety goggles when drilling holes in the cabinet bottom.

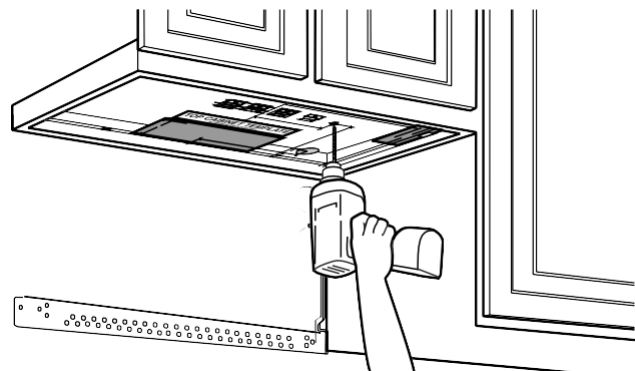

Check for Proper Damper Operation

- Place the microwave in its upright position, with the top of the unit facing up.
- The exhaust adaptor is only used for top and outside back exhaust. It is absent for models shipped for recirculation exhaust.
- Make sure the tape securing the damper is removed and the damper pivots easily before mounting the microwave.
- Attach the exhaust adaptor to the blower plate by sliding it into the guides. Secure the adaptor with a provided sheet metal screw.

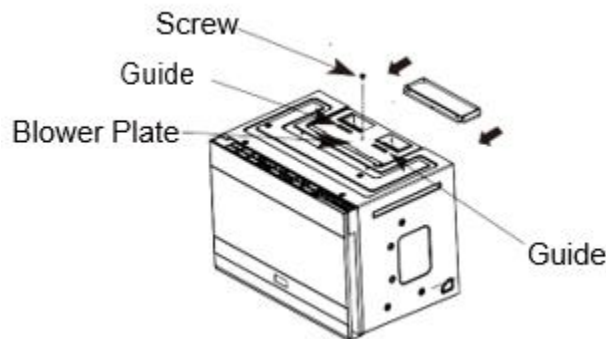
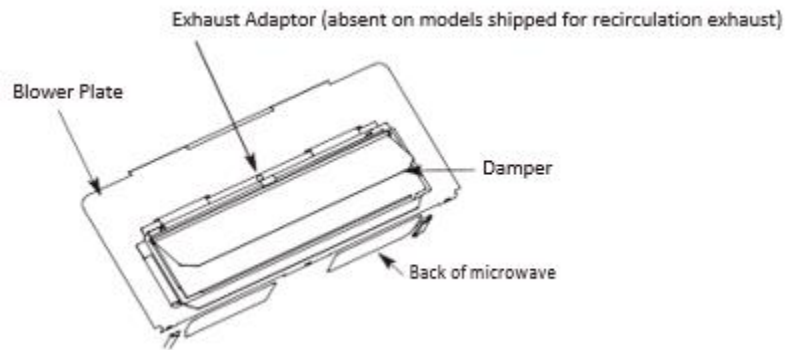

- You will need to adjust the damper ensure proper alignment with your house exhaust duct after the microwave is installed.

Mount the Microwave

For easier installation and personal safety, we recommend that two people install this microwave oven.

CAUTION: Do not grip or use the handle during installation. Also, if filler blocks are not used, damage to the microwave case may occur from over tightening screws.

NOTES:

- If your cabinet is metal, use the nylon grommet around the power cord hole to prevent the cutting of the cord.
- We recommend using filler blocks if the cabinet front hangs below the cabinet bottom shelf.
- When mounting the microwave oven, thread power cord through hole in bottom of top cabinet. Keep it tight throughout Step 1-3. Do not pinch the power cord or lift the oven by pulling cord.

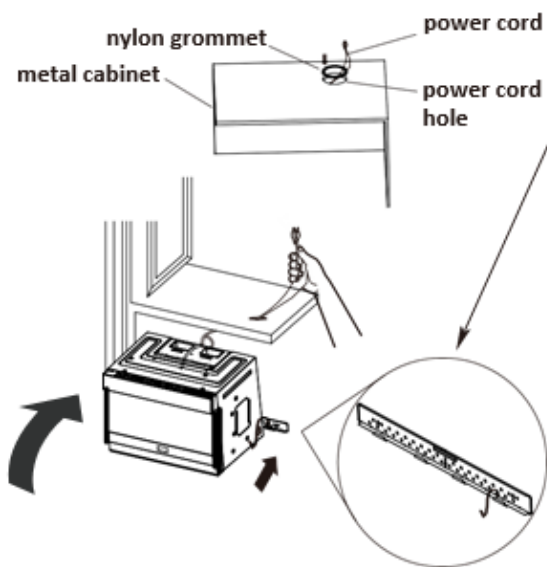

1. Lift the microwave, tilt it forward, and hook the slots at the back bottom edge onto four lower tabs of the mounting plate.
2. Rotate the front of oven up against cabinet bottom.
3. Attach the microwave oven to the top cabinet.
4. Insert 2 self-aligning machine screws (1/4"-20X3") through the outer top cabinet holes. Temporarily secure the oven by turning the screw at least two full turns after the threads have engaged. (It will be completely tightened later.) Be sure to keep power cord tight. Be careful not to pinch the cord, especially when mounting flush to the bottom of cabinet.

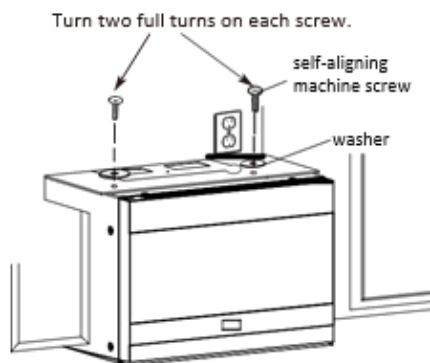

NOTE: The Filler Block is only used for recessed cabinets and front overhang cabinets. Place the Filler Block on the cabinet bottom before installing the oven.

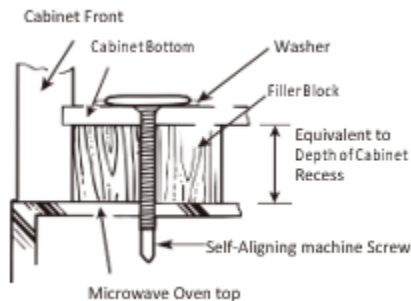

5. Tighten the outer two screws to the top of the microwave oven. (During tightening screws, hold the microwave oven in place against the wall and the top cabinet.)
6. Install the grease filters. (See the *User Manual* packed with the microwave.)

Adjust the Exhaust Adaptor

Open the top cabinet and adjust the exhaust adaptor to connect to the house duct.

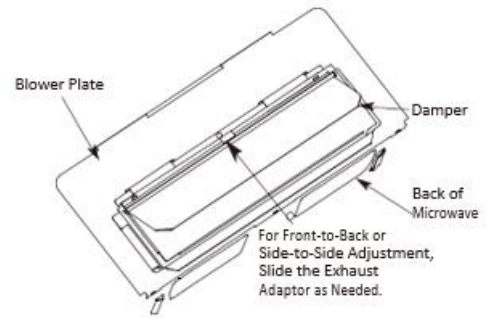

Connecting the Ductwork

1. Extend the house duct down to connect to the exhaust adaptor.
2. Seal exhaust duct joints using duct tape.

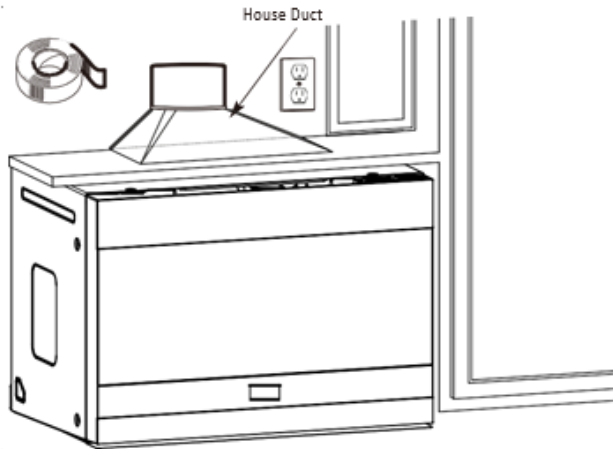

Installation Instructions for Outside Back Exhaust

Preparing the REAR Wall Template

Cut an opening (12" x 4" square) in the rear wall for an outside exhaust.

- Read the instructions on the REAR wall template.
- Tape it to the rear wall, lining up the A and B holes previously drilled in the wall plate.
- Cut the opening, following the instructions of the REAR wall template.

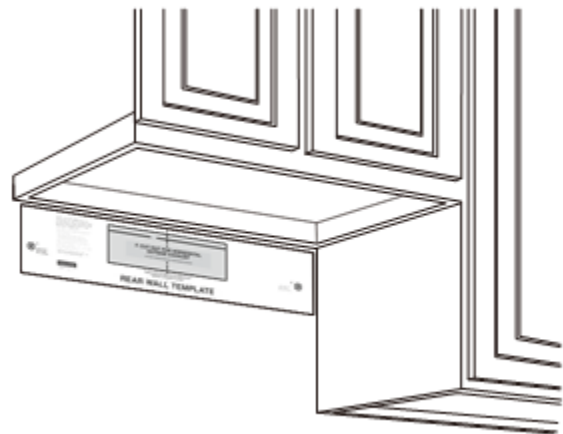

Attaching the Mounting Plate

Attach the mounting plate to the wall using the wing nuts and screws. At least one wood screw must be used to attach the mounting template to the wall stud.

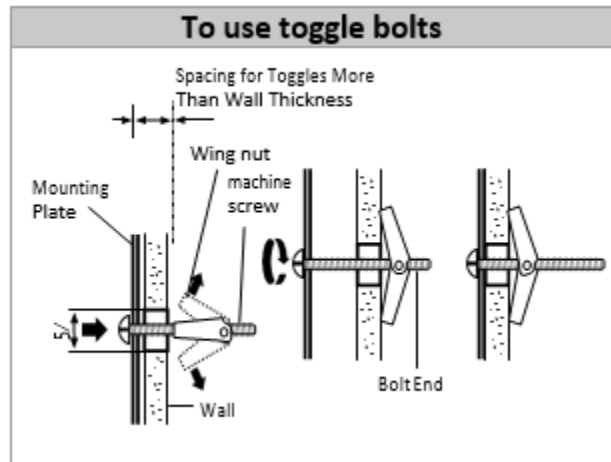
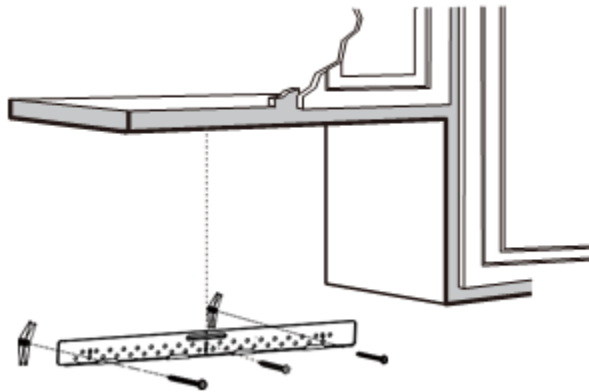

4. Remove the toggle wings from the bolts.
5. Insert the bolts into the mounting template through the holes designed to go into drywall, and reattach the toggle wings to $\frac{3}{4}$ " onto each bolt.
6. Place the mounting plate against the wall and insert the toggle wings into the holes in the wall to mount the plate.

NOTE: Before tightening toggle bolts and wood screw, make sure the bottom of the mounting plate touches the bottom of the cabinet when pushed flush against the wall and that the plate is properly centered under the cabinet.

Prepare the Top of the Cabinet

You need to drill holes for the top support screws large enough for the power cord to fit through, and a cutout large enough for the exhaust adaptor.

- Read the instructions on the TOP CABINET TEMPLATE
- Tape it underneath the top cabinet bottom
- Drill the appropriate holes, following the instructions on the TOP CABINET TEMPLATE

CAUTION: Wear safety goggles when drilling holes in the cabinet bottom.

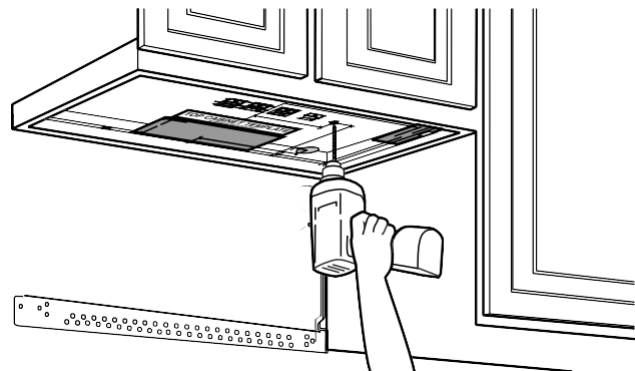

Adapting the Microwave Blower for Outside Back Exhaust

1. Remove and save the screw that holds the blower motor to the microwave. Lift up the blower plate.

- Carefully pull out the blower unit. The wires will extend far enough to allow you to adjust the blower unit.

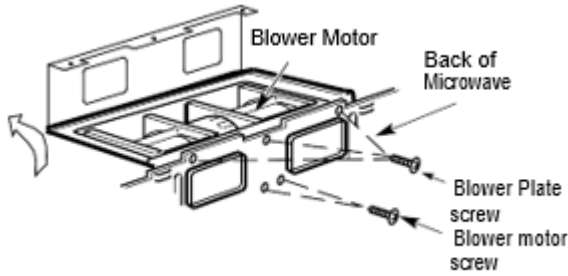

BEFORE: Fan Blade Openings Facing UP

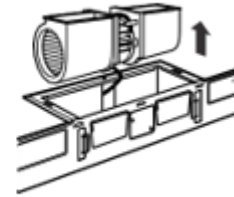

- Remove Part A with Nipper or Scissors.

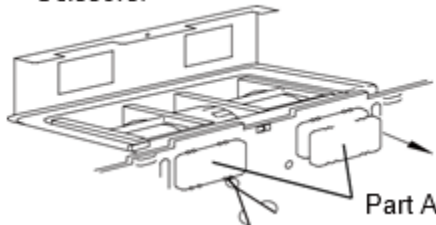

- Rotate blower unit counterclockwise 180°.

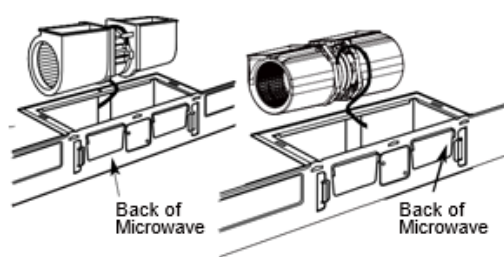

- Rotate blower unit clockwise 90°.

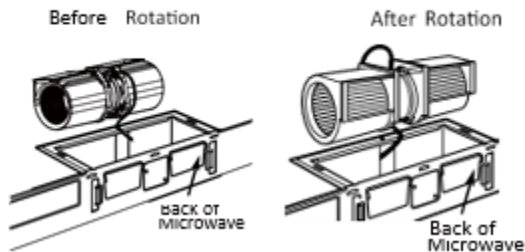

- Place the blower unit back into the opening.

After Fan Blade Openings Facing Back

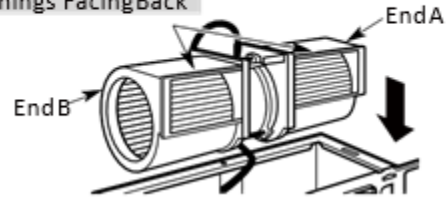

CAUTION: Do not pull or stretch the blower unit wiring, and take care to ensure all wires are not pinched.

NOTE: The blower unit exhaust openings should match the exhaust openings on the rear of the microwave oven.

- Replace the blower plate in the same position.
- Attach the exhaust adaptor to the rear of the oven by sliding it into the guides at the top center of the back of the microwave.

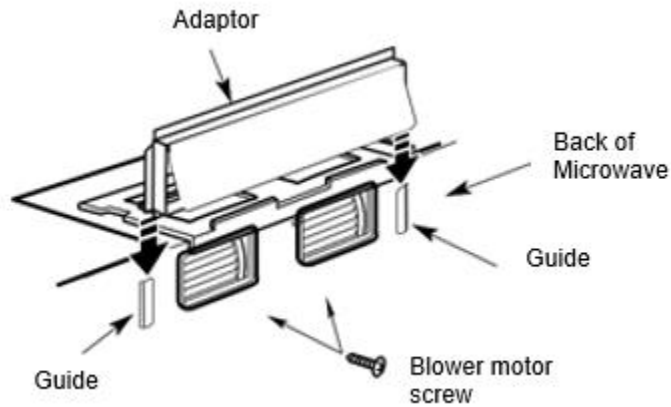

9. Push in securely until it is aligned with the blower motor screw holes. Be careful to assure that the damper hinge is installed so that it is at the top and that the damper swings freely.
10. Secure the blower motor unit to the microwave with the screw as before.

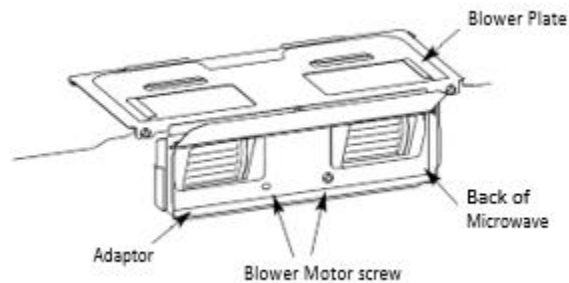

11. Secure the blower plate to the microwave with a screw. Replace the blower plate in the same position.

Mount the Microwave

For easier installation and personal safety, we recommend that two people install this microwave oven.

CAUTION: Do not grip or use the handle during installation. Also, if filler blocks are not used, damage to the microwave case may occur from over tightening screws.

NOTES:

- If your cabinet is metal, use the nylon grommet around the power cord hole to prevent the cutting of the cord.
- We recommend using filler blocks if the cabinet front hangs below the cabinet bottom shelf.
- When mounting the microwave oven, thread power cord through hole in bottom of top cabinet. Keep it tight throughout Step 1-3. Do not pinch the power cord or lift the oven by pulling cord.

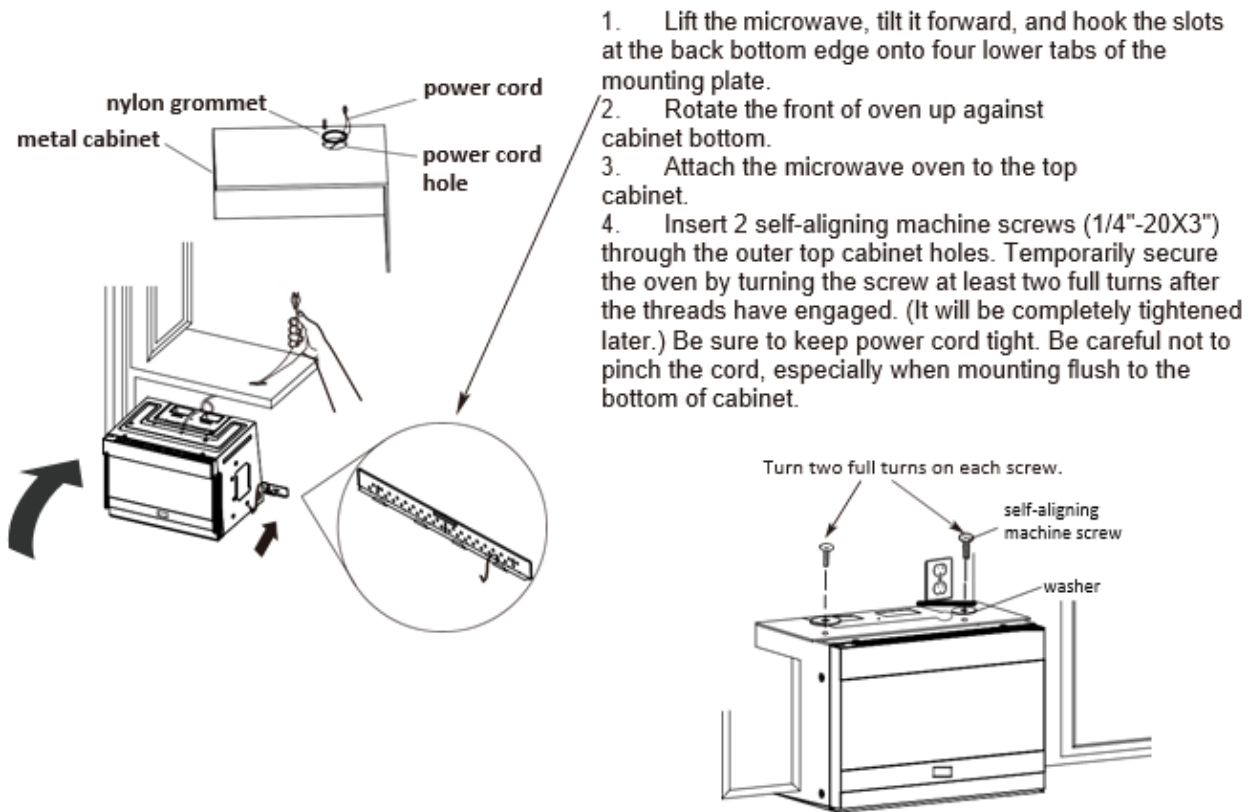

The Filler Block is only used for recessed cabinets and front overhang cabinets. Place the Filler Block on the cabinet bottom before installing the oven.

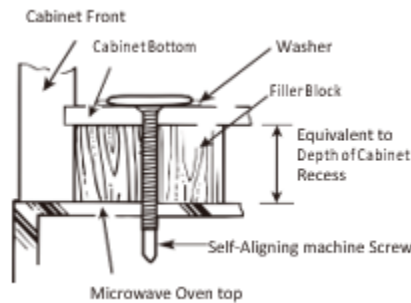

5. Tighten the outer two screws to the top of the microwave oven. (During tightening screws, hold the microwave oven in place against the wall and the top cabinet.)
6. Install the grease filters. (See the *User Manual* packed with the microwave.)

Installation Instructions for Recirculating Microwaves

Attaching the Mounting Plate

Attach the mounting plate to the wall using the wing nuts and screws. At least one wood screw must be used to attach the mounting template to the wall stud.

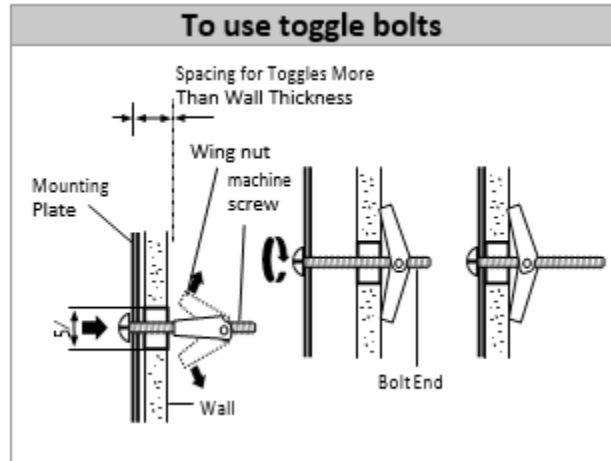
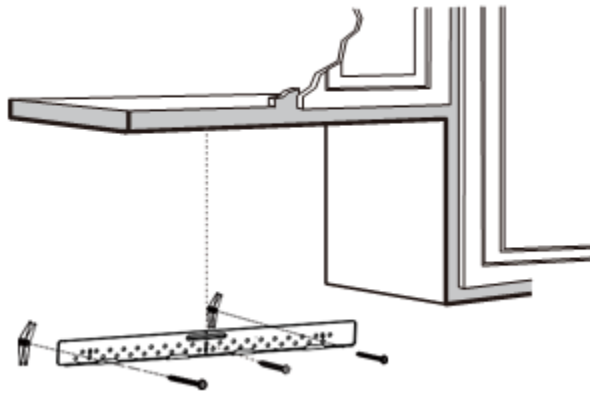

1. Remove the toggle wings from the bolts.
2. Insert the bolts into the mounting template through the holes designed to go into drywall, and reattach the toggle wings to $\frac{3}{4}$ " onto each bolt.
3. Place the mounting plate against the wall and insert the toggle wings into the holes in the wall to mount the plate.

NOTE: Before tightening toggle bolts and wood screw, make sure the bottom of the mounting plate touches the bottom of the cabinet when pushed flush against the wall and that the plate is properly centered under the cabinet.

Prepare the Top of the Cabinet

You need to drill holes for the top support screws large enough for the power cord to fit through, and a cutout large enough for the exhaust adaptor.

- Read the instructions on the TOP CABINET TEMPLATE
- Tape it underneath the top cabinet bottom
- Drill the appropriate holes, following the instructions on the TOP CABINET TEMPLATE

CAUTION: Wear safety goggles when drilling holes in the cabinet bottom.

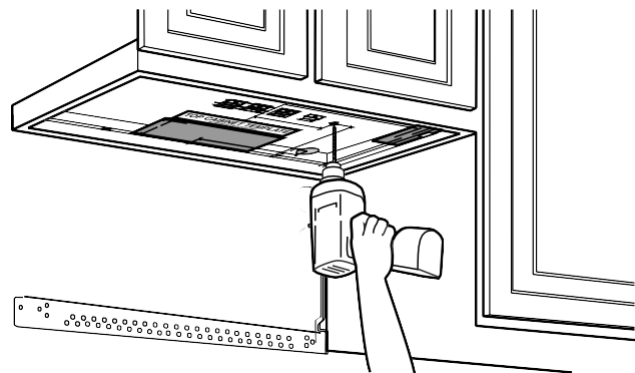

Adapting the Blower for Recirculation

1. Remove and save the screw that holds the blower motor to microwave. Lift up the blower plate.
2. Carefully pull out the blower unit. The wires will extend far enough to allow you to adjust the blower unit.

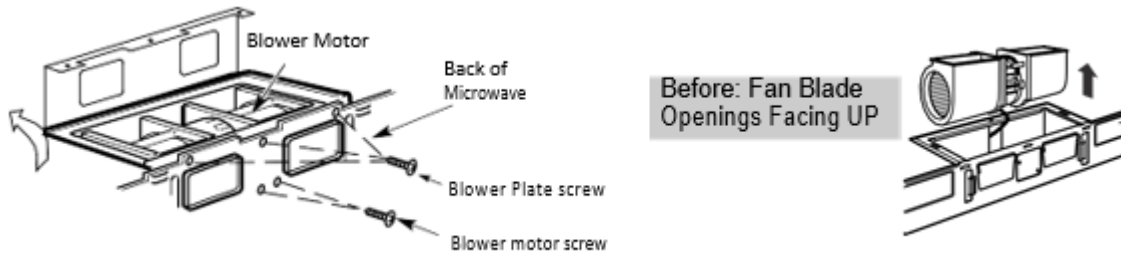

3. Rotate the blower unit 90°.

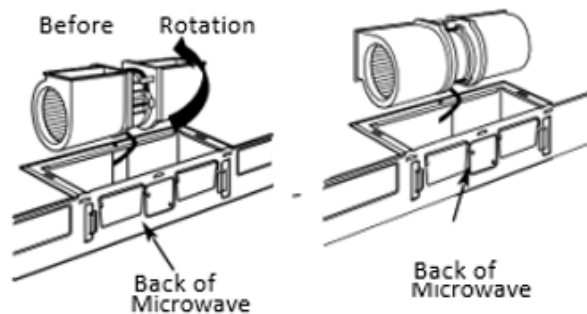

4. Place the blower unit back into the opening.

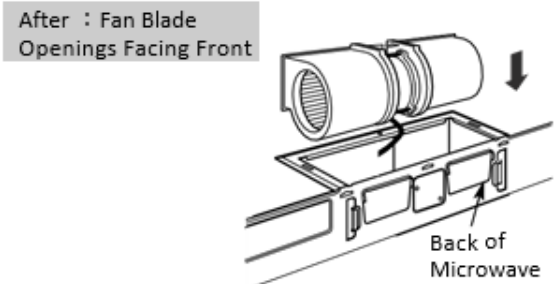

CAUTION: Do not pull or stretch the blower unit wiring, and take care to ensure all wires are not pinched.

NOTE: The blower unit exhaust openings should match the exhaust openings on the rear of the microwave oven.

5. Replace the blower plate back into its original position.

Mount the Microwave

For easier installation and personal safety, we recommend that two people install this microwave oven.

CAUTION: Do not grip or use the handle during installation. Also, if filler blocks are not used, damage to the microwave case may occur from over tightening screws.

NOTES:

- If your cabinet is metal, use the nylon grommet around the power cord hole to prevent the cutting of the cord.
- We recommend using filler blocks if the cabinet front hangs below the cabinet bottom shelf.
- When mounting the microwave oven, thread power cord through hole in bottom of top cabinet. Keep it tight throughout Step 1-3. Do not pinch the power cord or lift the oven by pulling cord.

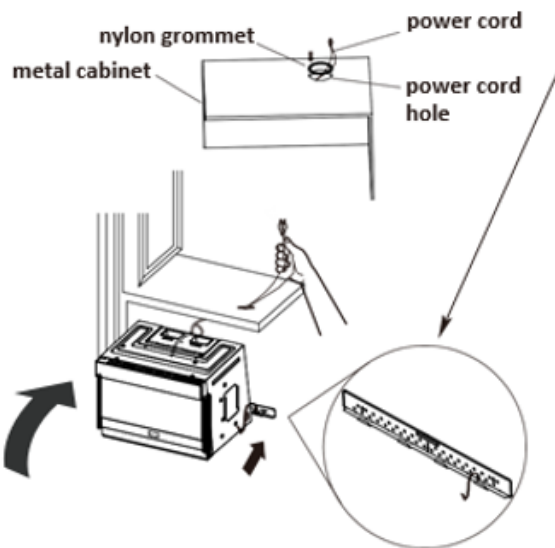

1. Lift the microwave, tilting it forward, and hook the slots at back bottom edge onto the four lower tabs of mounting plate.
2. Rotate front of oven up against the cabinet bottom.
3. Attach the microwave oven to the top cabinet.
4. Insert 2 self-aligning machine screws (1/4"-20X3") through the outer top cabinet holes. Temporarily secure the oven by turning the screw at least two full turns after the threads have engaged. (It will be fully tightened later) Be sure to keep power cord tight. Be careful not to pinch the cord, especially when mounting flush to the bottom of cabinet.

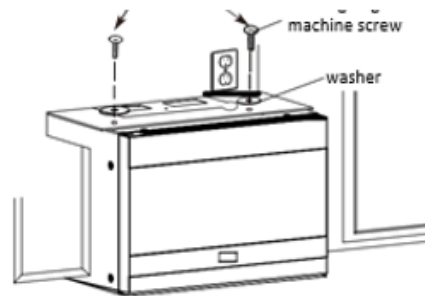

The Filler Block is only used for recessed cabinets and front overhang cabinets. Place the Filler Block on the cabinet bottom before installing the oven.

Tighten the outer two screws to the top of the microwave oven. (During tightening screws, hold the microwave oven in place against the wall and the top cabinet.)

7. Install the grease filters. (See the *User Manual* packed with the microwave.)

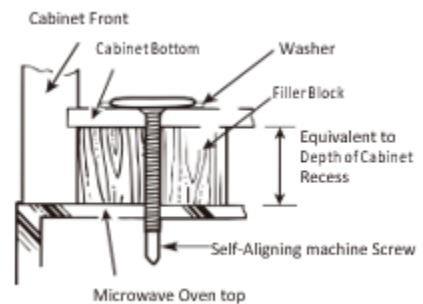

Changing the Charcoal Filter

The charcoal filter is used for non-vented, recirculated installations. The filter should be changed every six to 12 months, depending on use.

1. Remove the two screws from the louver, located on the top of the microwave oven by using a #1 Phillips head screwdriver.
2. Open the door, remove the louver, and remove the charcoal filter.

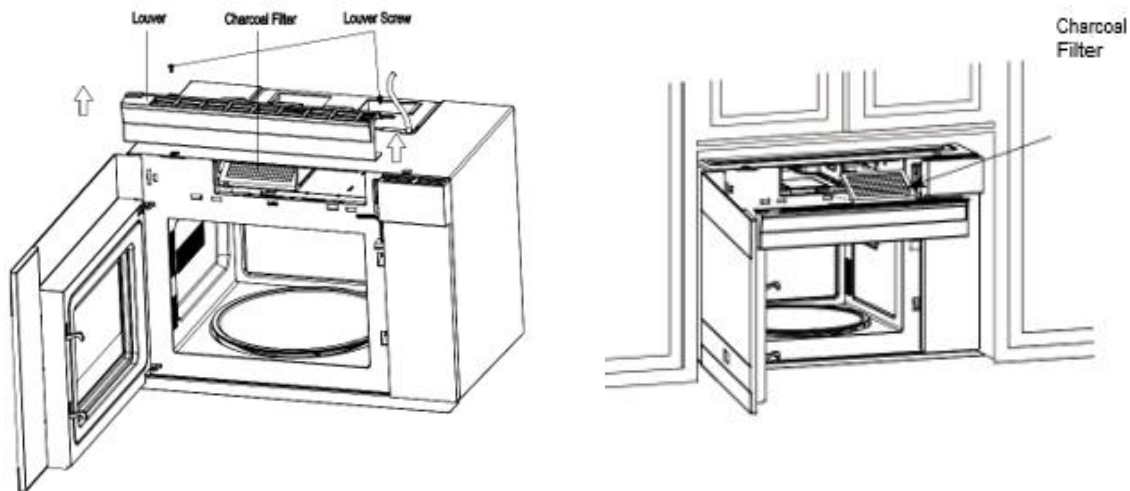

3. Install the new charcoal filter. When properly installed, the wire mesh of the filter should be visible from the front.
4. Replace the louver and the screws.

BEFORE USING YOUR MICROWAVE

1. Make sure the microwave oven has been installed according to these instructions.
2. Remove all packing material from *inside* the oven cavity.
3. Install the turntable and ring in the cavity.
4. Replace the house fuse or turn the appropriate circuit breaker back on.
5. Plug the power cord into a dedicated outlet.
6. Read the *User Manual* packed with your microwave oven.

BEFORE USING YOUR MICROWAVE

These wall mount templates can be found on the product page of your particular model on www.summitappliance.com.

