



SPR275OS2DPNRADA



31.88" x 26.75" x 23.25" (H x W x D)

27" wide 2-drawer built-in ADA compliant all-refrigerator designed for indoor or outdoor use with panel-ready fully finished stainless steel drawer fronts, approved for residential and commercial use

Highlights:

32 inch height allows easy installation under lower ADA compliant counters

Panel-ready drawers allow you to customize the look to match existing cabinetry

Flexible design allows for built-in or freestanding use in 27 inch wide spaces

Product Features:

27" wide 2-drawer all-refrigerator	Uniquely sized for built-in installation under counters in residential or commercial kitchen settings
Panel-ready drawer fronts	Drawers can be customized with overlay panels (sized at 26.77" x 13.78" at 3/4" thick) to match or accent existing cabinetry
ADA compliant design	32" height allows easy installation under lower ADA compliant counters
Less than 24" deep	Shallower depth than many similar units in this size class, allowing an easier fit in tight commercial or residential kitchen spaces
Stainless steel drawers	Interior and exterior drawer fronts feature weatherproof stainless steel construction in a horizontal grain for long-lasting luxury under the counter
Built-in capable	Front-breathing design allows the unit to be built-in under counters
Indoor/Outdoor compatible	Durable, weatherproof construction designed to hold up to the elements
Commercially approved	ETL-S listed to NSF-7 standards allows use in commercial kitchens
Wide temperature range	Temperature can be set between 34 and 65°F for versatile storage of food, beverages, wine, and other items



SPR275OS2DPNRADA Specifications:

Overview	
Height of Cabinet	31.88" (81 cm)
Width	26.75" (68 cm)
Depth	23.25" (59 cm)
Depth with Handle	25.25" (64 cm)
Depth with door at 90°	37.75" (96 cm)
Capacity	4.83 cu.ft. (137 L)
Defrost Type	Frost-Free
Door	Stainless Steel/Panel-Ready
Cabinet	Black
US Electrical Safety	ETL
Canadian Electrical Safety	ETL-C
Sanitation	ETL-S
Energy Usage/Year	303.0kWh/year
Amps	1.25
Voltage/Frequency	115 V AC/60 Hz
Weight	121.0 lbs. (55 kg)
Shipping Weight	170.5 lbs. (77 kg)
Parts & Labor Warranty	1 Year
Compressor Warranty	5 Years
UPC	761101090177
Refrigerator Features	
Sabbath Mode	Yes
Door Swing	Drawer
Height Adjustable	Yes
Thermostat Type	Digital
Fan Type	Interior and Exterior
Refrigerant Type	R600a
Refrigerant Amount	1.23oz.
High Side PSI	150.0
Low Side PSI	50.0
Level Legs Qty	4
Interior Light	Yes
Interior Drawers	Yes
Interior Drawers Qty	2
Temperature Range	34 to 65°F

Sound Level 35.2 dB

Drawer Dimensions

Interior Height 1	9.88" (25 cm)
Interior Width 1	21.0" (53 cm)
Interior Depth 1	16.5" (42 cm)
Interior Height 2	8.75" (22 cm)
Interior Width 2	21.0" (53 cm)
Interior Depth 2	16.5" (42 cm)

Dimensions

Compressor Step Height	5.0" (13 cm)
Compressor Step Width	21.0" (53 cm)
Compressor Step Depth	5.0" (13 cm)

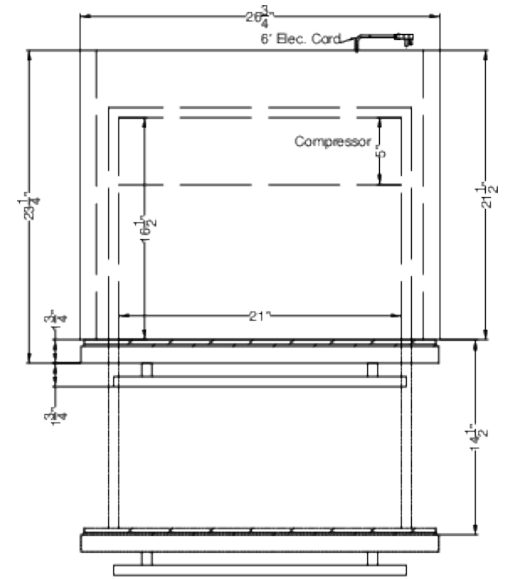

TOP VIEW

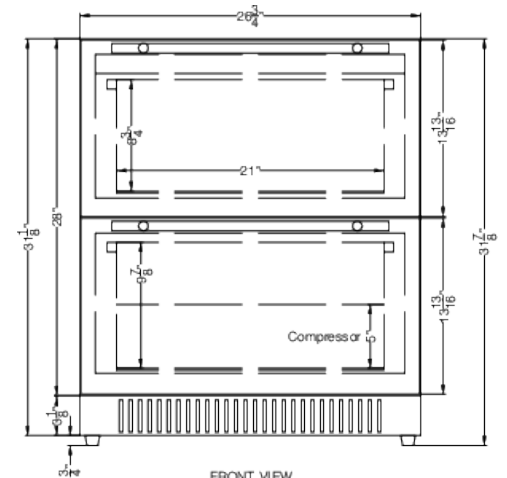

FRONT VIEW