



CR2B120WH



2.5" x 11.25" x 20" (H x W x D)

115V 2-burner radiant cooktop with smooth white ceramic glass surface and preinstalled cord

Highlights:

Two-burner electric cooktop with 120V operation

White ceramic surface in quality EuroKera glass

Stainless steel trim offers an added touch of modern style

Product Features:

EuroKera glass surface	Easier cleanup with a smooth ceramic top in a white finish
115V operation	Designed to work with standard 115V/60Hz electrical supplies with proper grounding
Cord included	Ships with 3-pronged cord preinstalled
Two heating elements	One 900W burner and one 500W burner in smooth ceramic glass
Push-to-turn controls	Prevents accidents by requiring a small amount of force to turn on cooktop heat
Indicator lights	Both burners are equipped with indicator lights to display when the cooktop is in use
ADA compliant design	Upfront controls and easy-to-operate knobs offer easier accessibility
Designed for built-in installation	Cutout dimensions: 10 1/8" W x 18 5/8" D



CR2B120WH Specifications:

Overview	
Height of Cabinet	2.5" (6 cm)
Width	11.25" (29 cm)
Depth	20.0" (51 cm)
Cabinet	White
US Electrical Safety	ETL
Canadian Electrical Safety	ETL-C
Amps	20.0
Voltage/Frequency	115 V AC/60 Hz
Weight	20.0 lbs. (9 kg)
Shipping Weight	13.0 lbs. (6 kg)
Parts & Labor Warranty	1 Year
UPC	761101059297
Electric Cooktop	
Heating Type	Radiant
Surface	Glass
Element Type	Glasstop
Number of Elements	2
Controls	Dial
Countertop Cutout Height	2.5" (6 cm)
Countertop Cutout Width	10.13" (26 cm)
Countertop Cutout Depth	18.63" (47 cm)
Element #1 Size	5.75" (15 cm)
Element #1 Wattage	500.0
Element #2 Size	7.0" (18 cm)
Element #2 Wattage	900.0

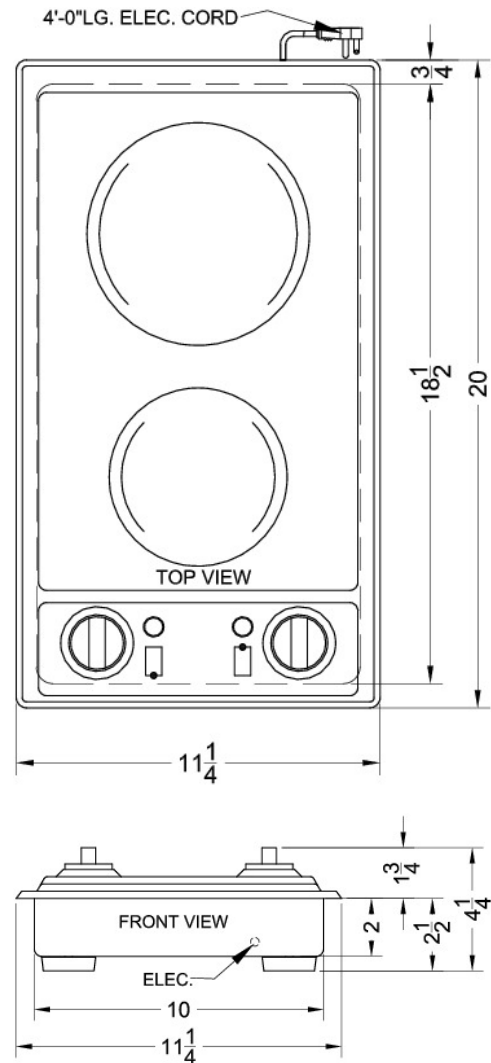

MODEL: CR2B120
120V-60HZ 1400W MAX.